Ball Bearing Design

Course No: M02-030

Credit: 2 PDH

Robert P. Tata, P.E.



Continuing Education and Development, Inc.
22 Stonewall Court
Woodcliff Lake, NJ 07677

P: (877) 322-5800
info@cedengineering.com

Ball Bearing Design

Copyright 2011
Robert P. Tata, B.S.M.E., P.E.
All Rights Reserved

Table of Contents

<u>Topic</u>	<u>Page</u>
Ball Bearing Basics	3
Ball Bearing Types	5
Internal Clearance	7
Ball Bearing Stress	9
Ball Loads	11
Ball Bearing Life	13
Preloading	15
Ball Bearing Closures	17
Ball Bearing Material	19
Ball Bearing Lubrication	20
<u>Figure</u>	<u>Page</u>
Figure 1	21
Figure 2	22
Figure 3	23
Figure 4	24
Figure 5	25
Figure 6	26
Figure 7	27
Figure 8	28
Figure 9	29
Figure 10	30
Figure 11	31
Figure 12	32
Figure 13	33

Note: Material for this course was obtained from publications whose owner has granted the author permission to use without being named.

Ball Bearing Basics

Ball bearings are used primarily to support rotating shafts in mechanical equipment. A ball bearing consists of an inner ring, an outer ring, a complement of balls, and a separator. See Figure 1. The inner ring outside diameter (IROD) and the outer ring inside diameter (ORID) have a groove in which the balls revolve around. The groove is commonly called the pathway. The raised surface on each side of the pathway is called the shoulder. The balls are held equally spaced around the annulus of the bearing by the separator. The basic dimensions of the bearing are the bore (B), the outside diameter (OD), and the width (W). Most bearings fall into three different series or categories based on their cross-sectional size with the larger sizes being able to support heavier loads. See Figure 2.

Ball bearings fall under an industry wide standard for their boundary dimensions. Tolerances for these dimensions have also been established so that the product from the various manufacturers can be used interchangeably. Tolerances have also been established for the surfaces that bearings mount on. It is standard practice to have the bearing rotating ring be a press fit on its mounting member and the non-rotating ring be a loose fit on its mounting member. Table 1 below lists the rotating inner ring fit and the stationary outer ring fit for a light series 40mm bore ball bearing for all five industry-wide Annular Bearing Engineers Committee (ABEC) standard fit classifications:

Table 1 – Rotating inner ring fit and stationary outer ring fit for a light series 40mm bore ball bearing

ABEC Number	Rotating Inner Ring	Stationary Outer Ring
1	.0009T-.0001L	.0001T-.0010L
3	.0006T-.0001L	.0001T-.0008L
5	.0004T-.0001L	.0000 -.0006L
7	.0003T-.0001L	.0000 -.0004L
9	.0001T-.0001L	.0000 -.0003L

Table 2 below lists the stationary inner ring fit and the rotating outer ring fit for the same 40mm bore ball bearing for all five industry-wide ABEC standard fit classifications:

Table 2 – Stationary inner ring fit and rotating outer ring fit for a light series 40mm bore ball bearing

ABEC Number	Stationary Inner Ring	Rotating Outer Ring
1	.0001T-.0009L	.0006T-.0005L
3	.0001T-.0006L	.0005T-.0004L
5	.0001T-.0004L	.0003T-.0003L
7	.0001T-.0003L	.00025T-.00015L
9	.0001T-.0001L	.0002T-.0001L

It can be seen from the table that as the ABEC number increases, the tolerances get tighter and the precision gets greater resulting in closer control of the fit of the rings on their mounting surfaces. ABEC 1 is the standard grade of ball bearing precision and is generally adequate for most ball bearing applications. ABEC 3 and ABEC 5 grade bearings are specified where narrower tolerances are required to give desired refinements in mounting and running characteristics. ABEC 7 and ABEC 9 are available for applications where extreme accuracy and true running are necessary. These super precision grades are used in aircraft, machine tool, and fine instrument service.

Ball Bearing Types

There are three basic types of ball bearings: radial, angular contact and double row. See Figure 3. Radial ball bearings are the most widely used of all types of bearings. They are designed to support primarily radial loads which act 90 degrees to the bearing axis of rotation. The deep groove type will also support moderate bi-directional thrust loads which act parallel to the bearing axis of rotation. The Conrad method is used to assemble radial bearings where the inner ring is placed off-center inside the outer ring and the balls are loaded into the crescent space that is formed between the two. See Figure 4. This method limits the number of balls that can be assembled into the bearing because of space limitations imposed by the inner ring outside diameter and the outer ring inside diameter. The IROD and the ORID are dimensioned to allow a deep groove for better support of thrust loads. Also, ring pathway wall thickness must be large enough to withstand compressive stresses from the balls on one side and hoop stresses from press fit assembly on the other. The assembled bearing is inseparable and may be equipped with seals, shields, and/or snap rings.

Angular contact bearings are single row ball bearings designed so the line of contact between the balls and pathways is at an angle to a line 90 degrees to the bearing axis of rotation. The angle between the two lines is called the contact angle as indicated as angle "a" on the top sketch of Figure 5. In angular contact ball bearings, one of the pathway shoulders is removed (usually on the outer ring) to allow assembly of a maximum complement of balls for increased load carrying capacity. Angular contact bearings support both radial and high unidirectional thrust loads. The second sketch on Figure 5 has two angular contact bearings mounted back-to-back. This type of mounting has good axial and radial rigidity and provides resistance to overturning moments and angular deflection. The third sketch on Figure 5 shows two angular contact bearings mounted face-to-face. This type of mounting has the same axial and radial rigidity as the back-to-back mounting but less resistance to overturning moments and more compliance to misalignment or shaft bending. The fourth sketch on Figure 5 has two angular contact bearings mounted in tandem (face-to-back). This mounting arrangement provides resistance to high thrust loading. The total thrust load capacity of the pair is 1.62 times the thrust capacity of one of the bearings. For even higher thrust loads, three or more angular contact bearings can be mounted in tandem.

Double row ball bearings support heavy radial loads, thrust loads from either direction, or combined radial and thrust loads. They are normally used in positions where radial loads exceed the capacity of a single row bearing with a comparable bore size. Double row bearings are designed with the bore and outside diameter the same as single row bearings but are narrower than two single row bearings. Figure 6 shows double row bearings with contact angles similar to two single row angular contact bearings mounted back-to-back (contact angle lines internally diverging) and face-to-face (contact angle lines internally converging). Double row bearings with contact lines internally diverging can be designed with preload giving it rigidity high enough to resist axial, radial, and overturning deflections, which makes it ideal for single bearing mounting such as for pulleys, gears, and wheels. Double row bearings with contact angle lines internally converging have the same resistance to axial and radial deflections as their counterparts but lack the resistance to angular deflections. Larger sizes have a loading groove in order to assemble a full complement of balls.

Internal Clearance

All radial ball bearings are normally built with a slight looseness called internal clearance. If measured in the radial direction, it is called "radial play" and if measured in the axial direction, it is called "end play". See Figure 7. Most bearings are built to radial play. The definition of radial play is the outer ring pathway diameter minus the inner ring pathway diameter minus twice the ball diameter. This is done in production by gaging the inner and outer ring pathway diameters and selecting a class of balls with a diameter that will result in the specified radial play. The purpose of radial play is as follows:

- 1) It permits interference fits with inner rings on shafts and outer rings in housings. Interference fits on shafts or in housings cause the bearing inner ring pathway diameter to expand in the case of press fit inner rings and the outer ring pathway to contract in the case of press fit outer rings. The amount of the expansion or contraction is 80% of the press fit. Having no radial play would cause the bearing to become internally preloaded which is not normally a good condition for radial ball bearings to be in for optimum performance.
- 2) It allows unequal thermal expansion of the shaft and the housing. Shafts normally run hotter than housings which will expand the inner ring more than the outer ring. This results in preloading the bearing if it had no internal clearance. Standard ball bearing life equations do not account for radial preloading of ball bearings.
- 3) Radial play allows the inner ring to misalign slightly with the outer ring without preloading the bearing thus accommodating shaft and housing manufacturing tolerances and shaft deflections under load.

The average standard radial play for a light series 40mm bore radial bearing is .00085 inch. The average ABEC 1 press fit for the same bearing rotating inner ring is .0004 inch. Eighty percent of .0004 is .00032 inch. Subtracting .00032 from .00085 yields .00053 inch which is the average running radial play for a light series 40mm bore bearing.

Standard radial play satisfies the requirements of most applications. For unusual applications, special radial play may be required. Less than standard radial play (.0002 inch average) may be required for bearings operating at low to moderate

speeds where accurate radial and axial location is critical. Higher than standard radial play (.00145 inch average) is specified for high speed and high thrust loads; however, high, no load acceleration can cause ball skidding and bearing damage with higher than standard radial play.

Ball Bearing Stress

The load that a radial ball bearing supports puts a compressive stress on the internal components. A radial load which acts 90 degrees to the axis of the shaft that a radial bearing supports, puts a vertical load on the bearing inner ring which puts a compressive stress on the balls which, in turn, puts a compressive stress on the outer ring. The next exercise demonstrates what effect the shape of the surface a ball is pressed against has on the compressive stress between the two. The equation for the compressive stress on a ball pressed against another ball of the same diameter is as follows:

$$S=64,000(P/d^2)^{1/3}$$

P is the compressive load and d is the ball diameter. Using the above equation, the compressive stress on a 9/32 inch ball pressed against another 9/32 inch ball with a load of 100 pounds is as follows:

$$S=64,000[100/(9/32)^2]^{1/3} =690,374\text{psi}$$

The equation for the compressive stress on a ball pressed against a flat plate is as follows:

$$S=40,000[(P/d^2)]^{1/3}$$

Using the above equation, the compressive stress on a 9/32 inch ball pressed against a flat plate with a load of 100 pounds is as follows:

$$S=40,000[100/(9/32)^2]^{1/3}=431,484\text{psi}$$

The equation for the compressive stress on a ball pressed against a curved convex surface (ball bearing inner ring) is as follows:

$$S=16,000f[P/(d^2)]^{1/3}$$

f is a stress factor which is dependent on ball diameter, ball circle diameter, and inner ring pathway radius of curvature (transverse plane). Using the above equation, the compressive stress for a 9/32 ball pressed against the inner ring of a light series 17mm bore radial ball bearing is:

$$S=16,000 \times 1.174 [100/(9/32)^2]^{1/3} = 202,625 \text{psi}$$

The above exercise shows that the shape of the surface that a ball is pressed against has a significant effect on the compressive stress that is generated between the two. The compressive stress of a ball pressed against a curved pathway surface such as a ball bearing inner ring is almost 3-1/2 times less than a ball pressed against another ball of the same diameter and less than half that of a ball pressed against a flat plate. The more that the inner ring pathway radius of curvature is made to conform to the ball diameter, the less the compressive stress becomes; however, there are practical limits in ball bearing design where too much conformity creates too much friction. A ball bearing inner ring pathway radius of curvature in the low 50 percent range of the ball diameter has been found to be the best value for optimum bearing performance. The outer ring pathway curvature can be made slightly higher than the inner ring because the outer ring, being a concave surface in the transverse (rotational) plane rather than the convex surface that an inner ring is, generates a lower compressive stress.

Ball Loads

Figure 8 has a sketch of a light series 17mm bore radial ball bearing with a complement of (8) 9/32 inch balls. Using the equations given on Figure 8, the load on ball numbers 1, 2, and 3 are as follows:

$$F_1 = 570 / (1 + 2\cos^{5/2} 45) = 310 \text{ lb}$$
$$F_2, F_3 = 310(\cos^{3/2} 45) = 184 \text{ lb}$$

It is desirable to design a new bearing with a larger capacity than 570 lb by adding another ball to the complement. The new bearing will be slightly larger in diameter since the new ball circle diameter will be slightly larger with the addition of the ninth ball. The ball loads for the new bearing using the same 570 lb load are as follows:

$$F_1 = 570 / (1 + 2\cos^{5/2} 40) = 281 \text{ lb}$$
$$F_2, F_3 = 281(\cos^{3/2} 40) = 188 \text{ lb}$$

It can be seen that by increasing the number of balls, the angle between them decreased from 45 degrees to 40 degrees lowering the most important "saddle ball" (F) load by 10%. The rated capacity of the new design is 620 lb, a 9% increase over the original bearing. (Rated capacity formulas are considered proprietary by bearing manufacturers).

Another option for the new design would be to leave the number of balls the same, but increase the diameter from 9/32 inch to 5/16 inch which is the next standard size. This design option would have about the same size ball circle diameter as the first design option and thus be about the same size bearing as the first design option. The ball loads for this design option would be the same as the original design since ball diameter does not enter into the equation. What will change will be the stress on the balls. The same equation that was previously used will be used again to compare the compressive stress on the saddle ball of all three designs:

$$S = 16,000 \times 1.174 [310 / (9/32)^2]^{1/3} = 295,335 \text{ psi (original design, 570 lb capacity)}$$
$$S = 16,000 \times 1.174 [281 / (9/32)^2]^{1/3} = 285,832 \text{ psi (option no. one, 620 lb capacity)}$$
$$S = 16,000 \times 1.174 [310 / (5/16)^2]^{1/3} = 275,322 \text{ psi (option no. two, 710 lb capacity)}$$

It can be seen that the stress for design option 2 with eight 5/16 inch balls is the lowest of the three and the rated capacity is the highest; 25% higher than the original design and 15% higher than design option one. This exercise demonstrates how important the role of ball diameter is in designing bearings. It makes up a high percentage of the factors that go into the rated capacity equation. Ball diameter should be made as large as possible in bearing design for the most efficient package.

Ball Bearing Life

When radial ball bearings operate, the balls are rotated into the load zone where they are compressed between the two rings and then rotated out where the compressed metal returns to its original state. After many revolutions of the bearings, this constant compression and expansion of metal leads to fatigue failure. The failure usually occurs as a spall (pit) in the inner ring. The inner ring is under more stress than the outer ring because, as previously discussed, it presents a convex surface to the ball in the rotational plane as opposed to the outer ring which presents a concave surface to the ball. The balls are not a high failure item because, each ball in the complement, besides being heat treated to a higher hardness and honed to a finer finish than the inner ring, rotates through the load zone only once for approximately every 2 and 1/2 times that a point on the inner ring rotates through the load zone.

The steel in ball bearings is a special clean grade; however, occasionally a random inclusion (impurity) in the steel will be found in the stressed area of one of the ball bearing components and cause premature failure. This is one of the reasons that ball bearing life is expressed as a B10 number. Great strides have been made to manufacture cleaner steel but not much can be done to prevent a rare inclusion from appearing in a highly stressed area of a bearing. The B10 number is a calculated number of hours that 90% of the bearings are expected to achieve in their lifetime under a specified load and speed without failure. The formula for the B10 life of a ball bearing is as follows:

$$L=3000[C/(RxF)]^{10/3} \times(500/ S)$$

L is the life in B10 hours. C is the capacity of the bearing found in industry catalogs and is the number of pounds of load that the bearing can support for 3000 hours of operation at 500 rpm. The factors in the capacity equation include steel cleanliness and quality, ball diameter, number of balls, and inner ring curvature with ball diameter being by far the largest contributor to the rated capacity of a ball bearing. R is the radial load imposed by the application. F is a factor that takes into account any thrust load that may be acting on the bearing and is found in industry catalogs. S is the application speed in rpm. It can be seen that, because of the 10/3 power exponent, bearing life is especially dependent on load and not as dependent on speed which has no exponent. Should a bearing operate under a number of loads and speeds, the following equation is used:

$$L=1/[(t_1 /L_1)+(t_2 /L_2)+(t_3 /L_3)+etc]$$

L is the bearing in B10 hours. t is the percent of time spent at each different life (L) condition. Bearing life can be calculated to other values such as B5 and B1 should the application require it.

Preloading

It is important to design machines so that the products they manufacture are made as accurately as possible. One way to do this is to ensure that the shafts and spindles are rigidly supported and run true. The graph at the top of Figure 9 has a load vs. deflection plot for a typical angular contact bearing. It can be seen that the slope is the greatest at the beginning of the curve and becomes less and less as the curve progresses to the right. If something could be done to make the bearings run higher on the curve, spindles that they support would be more rigidly supported and run truer. The method that is used to do this is called preloading.

Figure 10 has a sketch of a spindle supported by two angular contact bearings. The inner rings of the bearings are clamped tight against the shaft shoulder. Each outer ring is mounted in its own sleeve. Torquing the nut N puts an axial load on the right hand (back) bearing through sleeve B. This load is then transferred through the clamped inner rings to the front (left) bearing preloading the bearings and putting the shaft in tension.

Let us assume that the nut N is torqued so that a preload of 3000 pounds is put on the bearings and shaft and that a work force of 2500 pounds is applied to the right on the front (left) end of the shaft. This additional force increases the load on the front bearing while decreasing the preload (tension) on the shaft and decreasing the load on the rear bearing. The front bearing is now supporting less than the preload and the additional work load ($3000+2500=5500$ lb) and the rear bearing is supporting less than the 3000 lb preload. Both bearings are now operating above the steepest part of the curve and are giving the shaft greater support and accuracy.

The two additional plots on Figure 9 can be used to determine the load and deflection of each of the two spindle angular contact bearings. The middle plot shows that the part of the curve from 0 to 3000 lb is rotated up. The load of 3000 lb was chosen because it is the initial preload that was put on both bearings. The section of plot was rotated up because this is the path taken when preload is being relieved. The lower chart shows that this part of the curve is moved to the right to 5500 lb which is the momentary load on the front bearing. Moving up the transplanted curve from 5500 lb to the original curve shows that the final load on the front bearing is 4500 lb. Applying the distance R to the 3000 lb line of the original curve shows that the rear bearing final load is 2000 lb. Without preload, the 2500 lb work load would have produced a shaft deflection of .003 inch, but

with preload, that deflection is down to .001 inch which is a big gain when considering the fact that many ball bearing component manufacturing tolerances are less than .0001 inch.

With the preload set at 3000 lb, it can be seen on the graph that each bearing deflects .0035 inch. In order to reduce the preload down to zero, the spindle would have to be deflected twice that amount or .007 inch. The force to eliminate the preload can be seen on the graph to be 10,000 lb or 3.33 times the amount of the preload itself.

A double row ball bearing can be manufactured preloaded. The graph on Figure 10 compares the load vs. deflection curve of a double row ball bearing to a similar sized non-preloaded single row ball bearing. The double row ball bearing preload is relieved at 5000 lb. After that, the two plots are parallel being 5000 lb apart on the horizontal scale.

Ball Bearing Closures

Bearing closures are sealing devices that are installed on one or both sides of a bearing to contain grease lubricant, to protect against dirt or foreign object entry, or to control the flow of lubricant entry when the bearing is exposed to an oil sump. Grease and double sealed bearings offer maintenance free operation for the life of a ball bearing.

At the top of Figure 11 is a sketch of a single rubber lip seal installed on a standard width ball bearing. The ability to design and assemble effective sealing elements on both sides of a standard width ball bearing without going outside of the bearing envelope and to grease lubricate the bearing for a lifetime of operation offers a distinct advantage to the designer in packaging mechanical devices over having to provide an alternate means of lubrication for the bearing or having to provide extra space to accommodate an extra wide sealed bearing.

The seal design shown at the top of Figure 11 has rubber molded around a flat steel ring insert which imparts rigidity and strength to the construction and helps to control sealing lip pressure which is needed to accommodate small movements of the inner ring. The seal is snapped into a groove in the outer ring where the rubber provides a leak proof joint. A standard design synthetic rubber seal has an operating temperature range of -65°F to 225°F . There are other similar materials available for higher temperature operation. The limiting speed of operation is 2000 rpm for a large 70mm bore bearing to 13,000 rpm for a small 10mm bore bearing.

Another version of the single lip seal is shown as the second from the top on Figure 11. It consists of a steel shield on the outside with a rubber lip seal molded on the lower inside. The metal is positioned on the outside to protect the bearing internals from hard foreign objects entry. The metal is crimped into a groove on the outer ring and becomes a permanent part of the bearing. The operating temperature range and limiting speed of operation are the same as for the standard snap-in single lip seal design.

The third sketch down on Figure 11 is of a triple lip seal with the outer steel shield protection the same as was discussed on the previous single lip seal. The seal is called "land riding" because the three lips ride on the inner ring outer diameter rather than on a notch as the previous two seals did. Besides having triple lips for triple sealing, grease is packed between the lips to further impede contaminant and

moisture entry, and to lubricate the lips. This concept is the ultimate in lip seal design for heavy duty applications. The drag of the three lips causes an increase in the torque level of the bearing; consequently, speeds are limited to 30 rpm for the large size bearing mentioned above to 2500 rpm for the small size bearing. It is commonly used on farm machinery, construction equipment and automotive in-line engine waterpump bearings.

The fourth sketch down on Figure 11 is a felt seal. It is held between two steel pieces which are crimped into a notch in the outer ring. Felt element seals are good for lubricant retention and light particle entrance and their low friction allows for higher speeds of operation than all other seal designs. Limiting speed is 3000 rpm for the large size bearing and 19,000 rpm for the small bearing. Limiting temperature is 275°F which is the charring temperature of the felt element.

The bottom closure on Figure 11 is a one-piece all metal design called a shield. It is crimped permanently into a groove in the outer ring. It does not contact the inner ring so it does not have a limiting speed other than what the bearing has. It is used to contain grease or control the amount of oil flowing into the bearing when exposed to an oil sump. Excessive oil in a bearing can cause an unusually high running torque and premature failure.

Ball Bearing Material

The specifications for ball bearing steel are very demanding. In normal service, the steel must withstand compressive stresses of 200,000 to 300,000 psi and, in extreme service, compressive stresses of 500,000 psi and above.

The standard grade steel for ball bearings is high carbon, high chromium, vacuum degassed AISI/SAE 52100. The high carbon content of 1% makes the steel responsive to heat treatment which results in very high strength and hardness. The high chromium content of 1.35% further increases response to heat treatment and adds depth to hardness penetration. Vacuum degassing removes impurities making the steel extra clean. For extremely critical applications, consumable electrode vacuum melted steel is available for an even higher degree of cleanliness and uniformity than what vacuum degassed steel provides.

Rings and balls are heat treated to the RC60 level for optimum toughness and strength at operating temperatures up to 300°F. For operating temperatures over 300°F, the steel softens and loses dimensional stability. A special stabilization heat treat procedure is available for continuous operation at temperatures up to 400°F. Stabilization tempers the steel at a temperature above what is encountered in service resulting in a slight decrease in hardness from the RC60 level.

Stainless steel is used for rings and balls for corrosion resistance and high temperature operation. For even higher operating temperatures up to 1100°F, special tool steels and cobalt base alloys can be used.

Separator steel for most bearings is low carbon steel. Most angular contact bearings operating at high speed use a non-metallic separator material. Non-metallic material combines low friction, light weight, and strength at temperatures up to 275°F. With higher temperatures and speeds, iron silicon bronze and phosphor bronze provide low friction and a high strength-to-weight ratio. For temperatures up to 1000°F, S-Monel, special tool steel and alloy steel are available. Figure 12 gives temperature limitations of the various bearing and separator materials.

Ball Bearing Lubrication

Highly refined mineral oils are among the best lubricants for ball bearings. Synthetics have been developed that are good but some do not form elastohydrodynamic films as well as mineral oils. Commonly used means for delivering oil to bearings include jet, bath, mist, and wick feed. The best overall system is oil jet combined with a recirculating system. This method directs a pressurized stream of oil at the bearing load zone. The oil is then drained back to a sump where it is filtered, cooled, and returned. This system is good for a wide variety of loads and speeds. The oil bath method is commonly used in gear boxes. The housing is filled with oil until it just touches the lowest rotating component. The oil is then splashed throughout the gearbox during operation. Mist systems use pressurized air to atomize oil. The mixture is then sprayed on the bearing where it lubricates and cools. Air-oil mist systems are used primarily for high speed applications. Wick systems use an absorbent material to store oil and slowly deliver it to a bearing in a controlled manner. This system is used in electric motors.

A simple method of lubricating bearings is by using grease. A carefully measured quantity of grease is evenly distributed throughout the bearing where it is contained by seals or shields. This configuration can run for the life of the bearing. Grease consistency is important. Greases too soft will cause excessive churning losses in a bearing while greases too hard will not lubricate properly. The following is a list of important greases:

- 1) Mineral oil grease for general purpose operation from -30°F to $+300^{\circ}\text{F}$.
- 2) Ester based greases operate from -100°F to $+350^{\circ}\text{F}$.
- 3) Silicone greases operate from -100°F to $+450^{\circ}\text{F}$ but lack good load carrying characteristics.

Figure 13 is a chart which can be used to determine the proper oil viscosity for various size bearings running at various speeds. First multiply the bearing bore (inside diameter) by the rpm. Locate the number on the upper left hand scale of the chart. Draw a horizontal line to the diagonal line (upper right). At the intersection, draw a vertical line down to the horizontal line that represents the operating temperature of the bearing. Read the oil viscosity at this intersection.

FIGURE 1

Ball Bearing Terminology

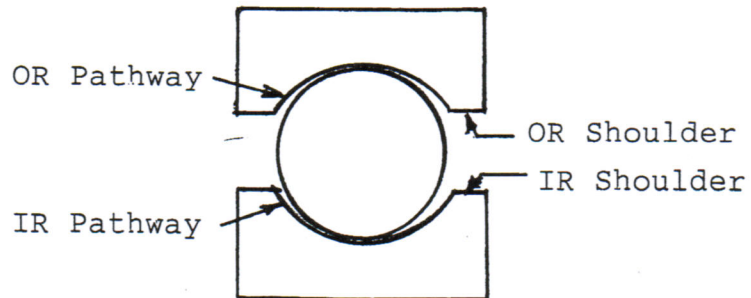
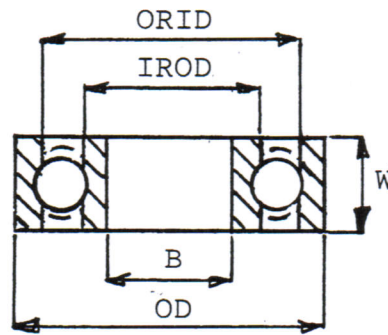
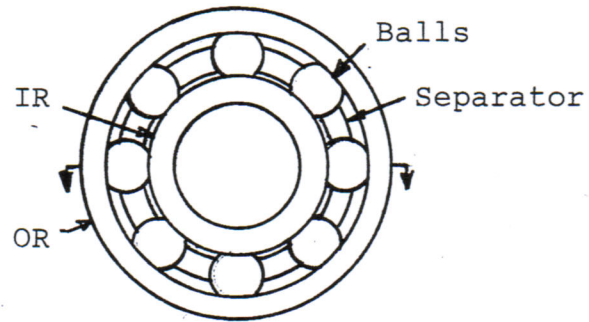

(Enlarged Section)

Figure 2

Ball Bearing Series

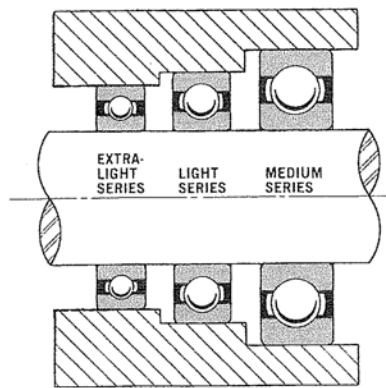

Relative Proportions of Bearings
With Same Inside Diameter

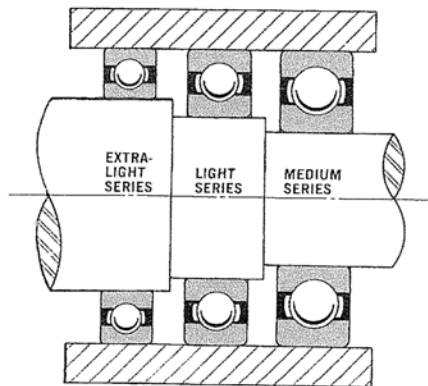

Relative Proportions of Bearings
With Same Outside Diameter

Figure 3
Types of Ball Bearings

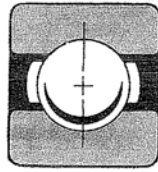

Radial

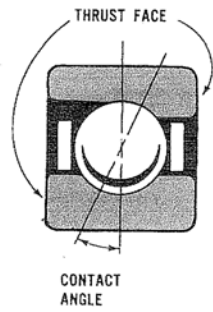

Angular Contact

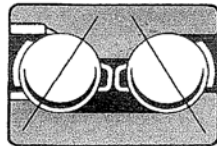

Double Row

Figure 4
Conrad Assembly

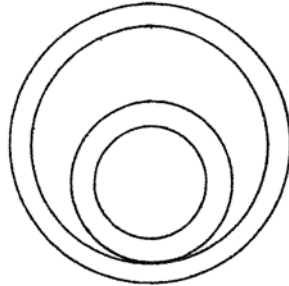

The IR is placed off-center inside the OR.

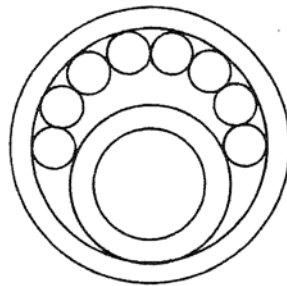

The balls are placed in the open space.

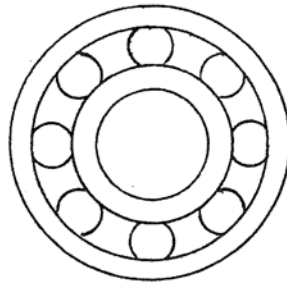

The IR is centered and the balls spaced.

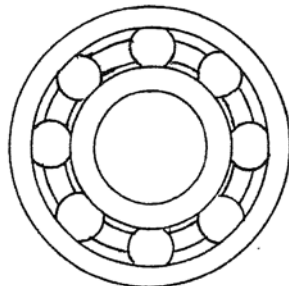

The separator is installed.

Figure 5
Angular Contact Ball Bearing

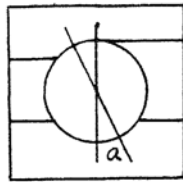

Angular Contact (a)
Ball Bearing

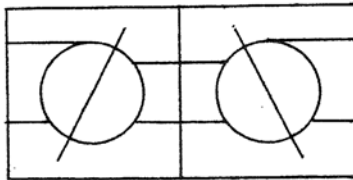

Back-to-Back
Mounting

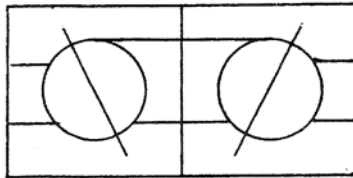

Face-to-Face
Mounting

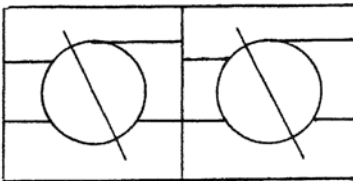

Tandem
Mounting

Figure 6

Double Row Ball Bearings

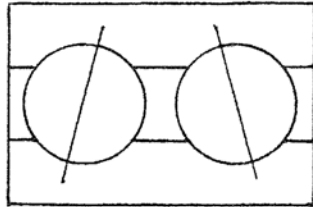

Double Row
Internally Divergent

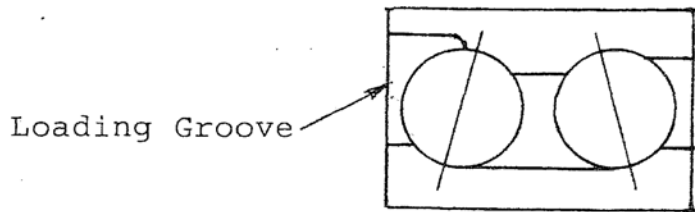

Internally Divergent
Larger Sizes

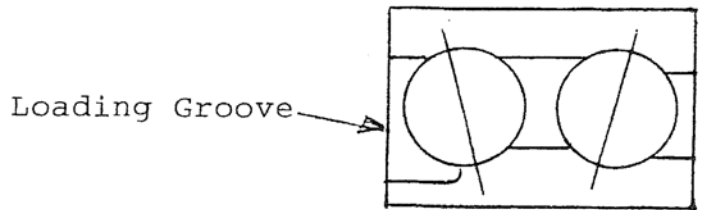

Double Row
Internally Convergent

Figure 7
Internal Clearance

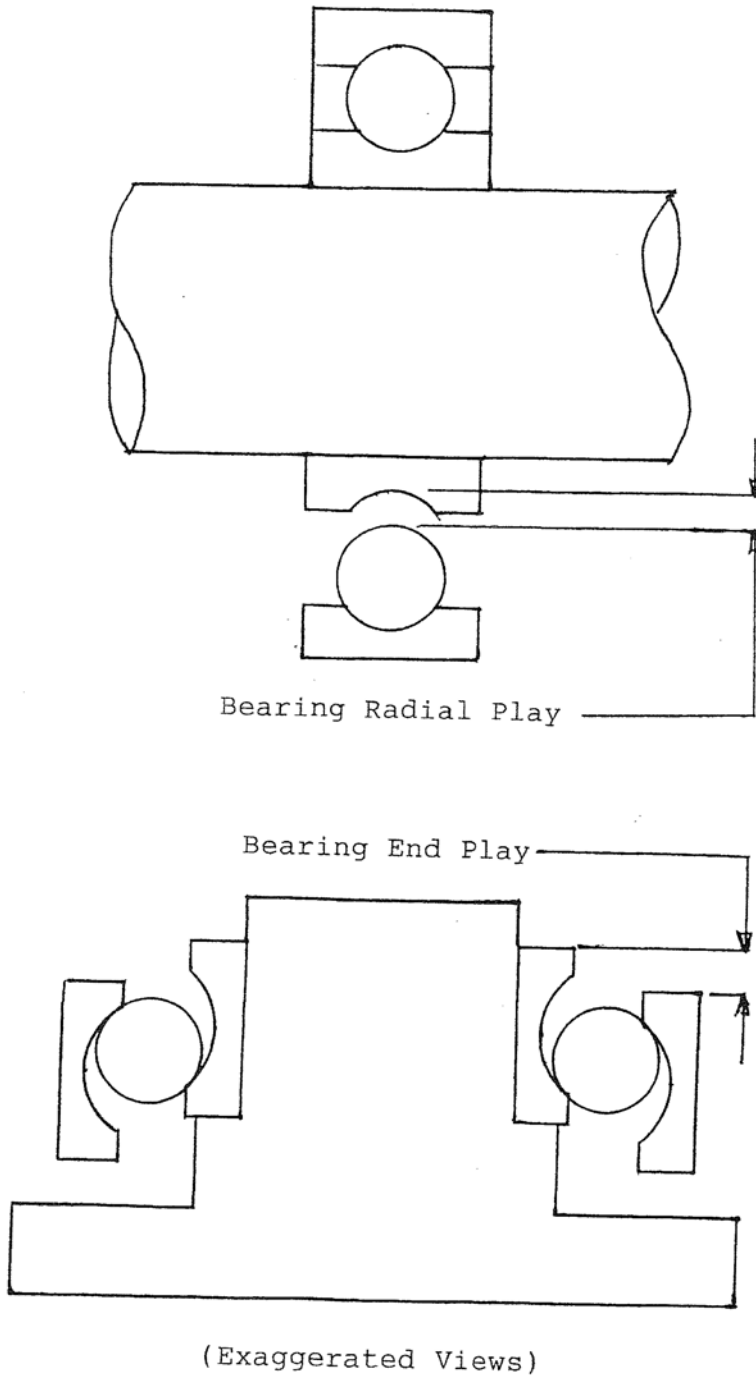
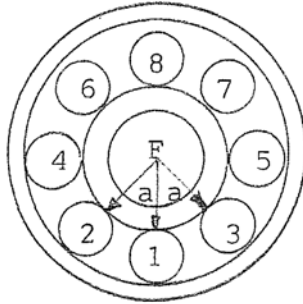

Figure 8
Ball Load Distribution



Exaggerated View Showing Effect of
Radial Load on Ball Force Distribution

With radial load acting down on inner ring:

- 1) Ball number 1 is the heaviest loaded.
- 2) Balls 2&3 are the next heaviest loaded.
- 3) Balls 4,5,6,7,&8 are unloaded.

$$\text{Radial Load} = F_1(1+2\cos^{5/2}a+2\cos^{5/2}2a+\text{etc})$$

$$\text{Load on Balls 2\&3} = F_1\cos^{3/2}a$$

Using the above equations with radial load = 570lb:

(570lb = rated load of above bearing)

- 1) Load on ball 1 = 310 lb

- 2) Load on ball 2&3 = 184 lb each

Figure 9

Angular Contact Ball Bearing

Deflection in inches vs axial load in pounds

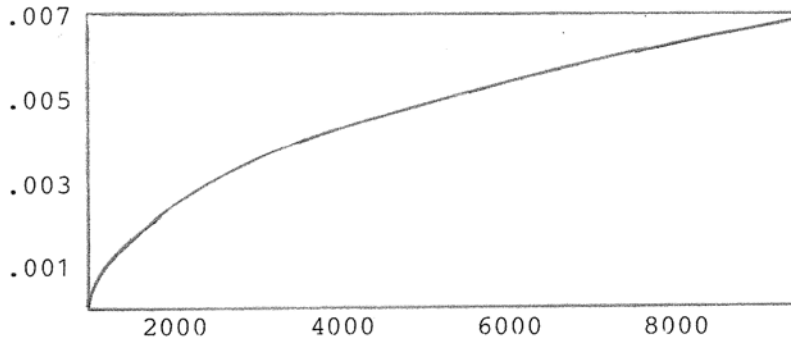

Typical Load vs Deflection Curve

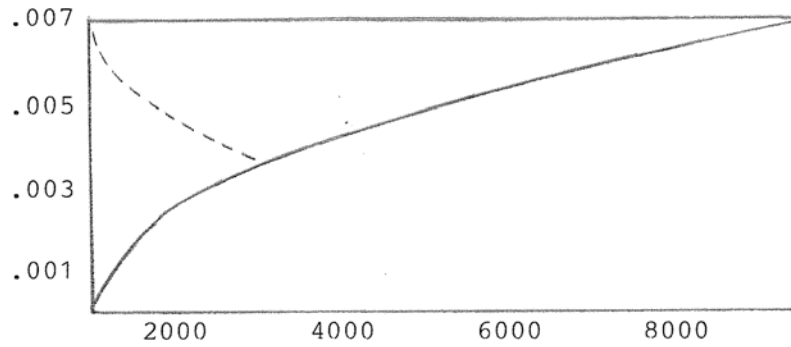

0 to 3000# Part of Curve Rotated Upward

Rotated Part of Curve Moved to 5500#

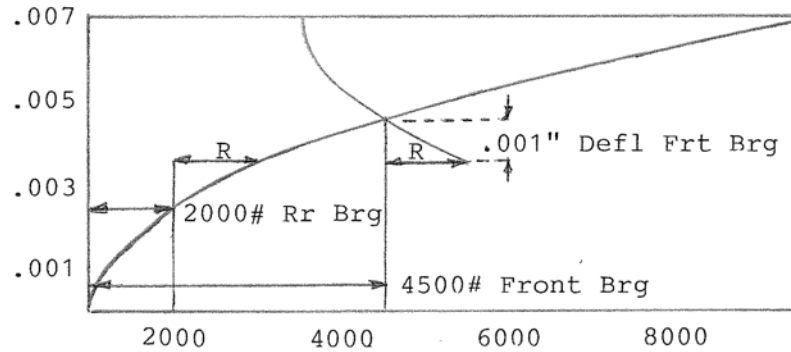
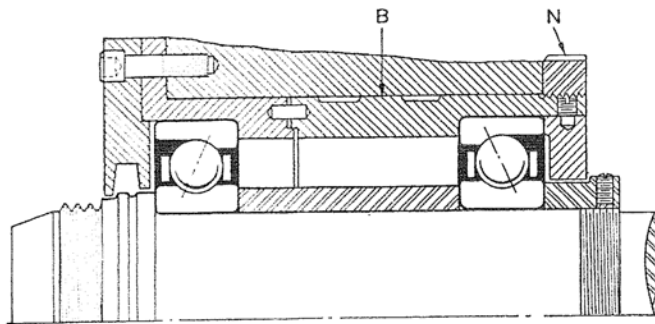
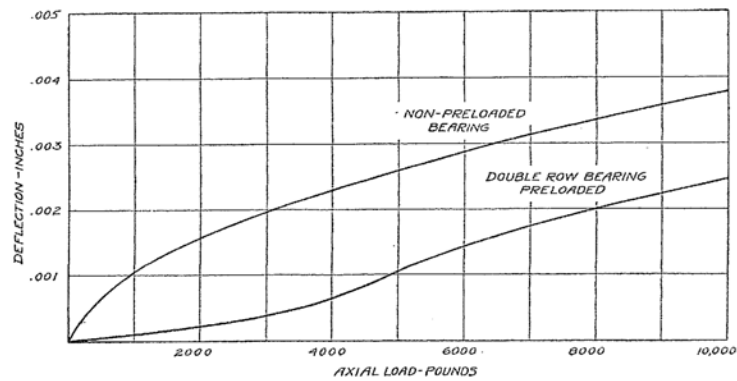

Figure 10
Bearing Preloading



Preloaded Angular Contact Bearings



Non-Preloaded vs Preloaded
Double Row Bearing

Figure 11
Ball Bearings Closures

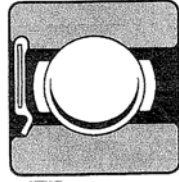

Standard Rubber Lip Seal

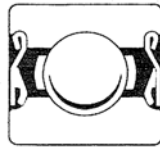

Lip Seal With Outer Guard

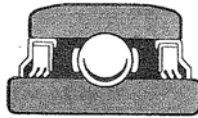

Triple Lip Seal With Guard

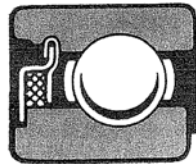

Felt Seal

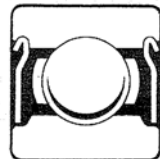

Double Shields

Figure 12
Ball Bearing Material

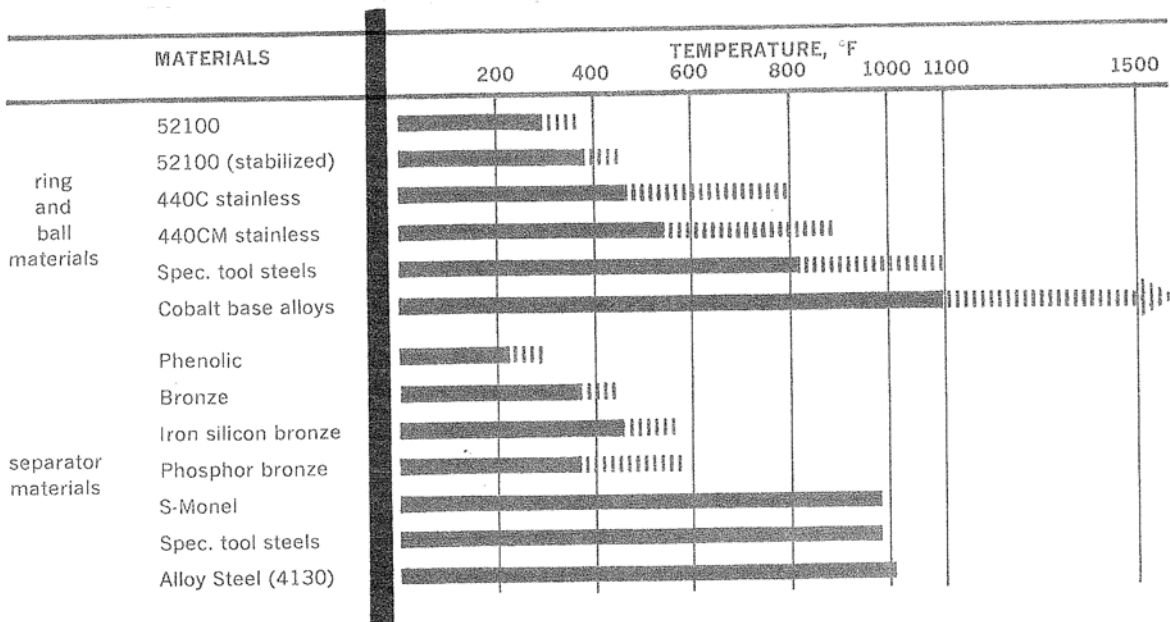

Ball Bearing Ring, Ball, and Separator
Material Temperature Limitation

Figure 13

Ball Bearing Lubrication

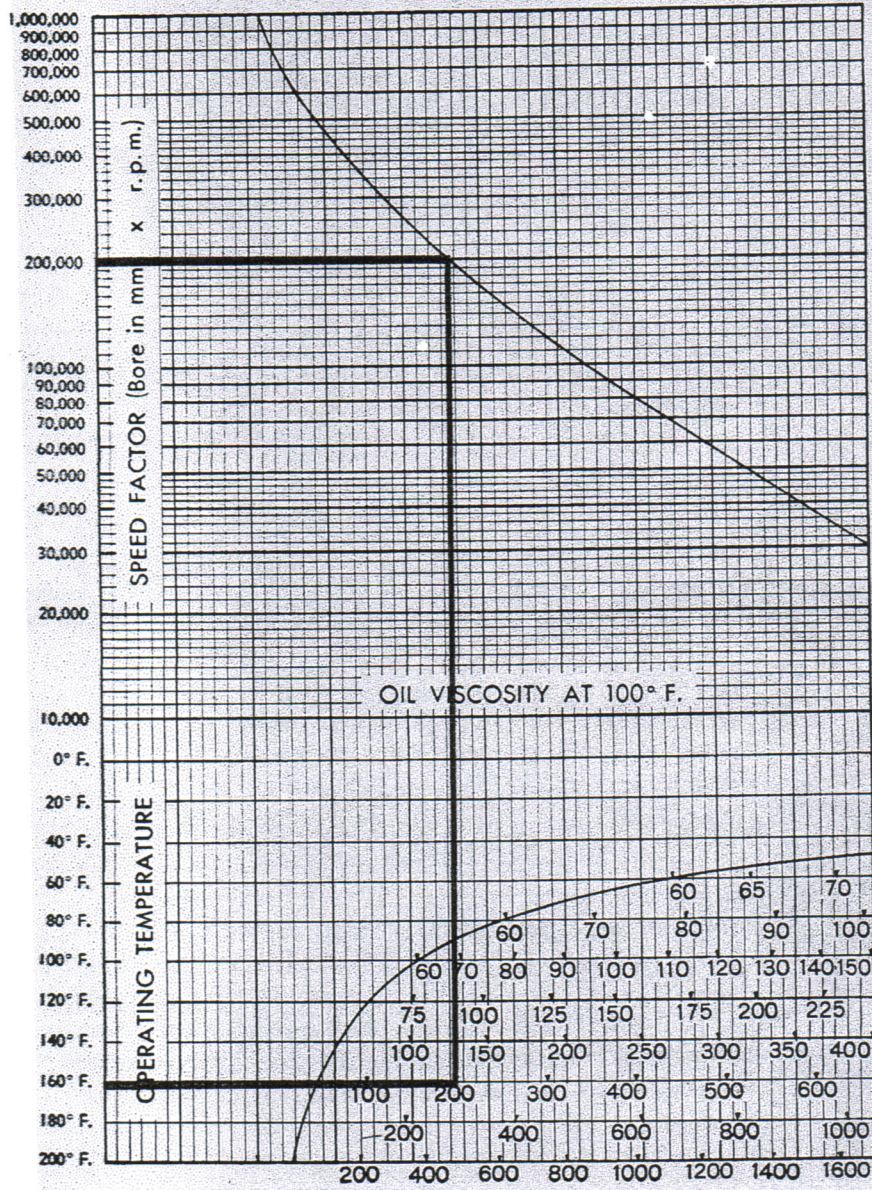

Chart to Determine
Correct Oil Viscosity